

Instructions for use QUATTROcare PLUS 2124 A - 1.008.3805



Always be on the safe side.



KaVo. Dental Excellence.

Distributed by:
KaVo Dental GmbH
Bismarckring 39
D-88400 Biberach
Phone +49 (0) 7351 56-0
Fax +49 (0) 7351 56-1488

Manufacturer:
Kaltenbach & Voigt GmbH
Bismarckring 39
D-88400 Biberach
www.kavo.com



Table of contents



1	User instructions	3
1.1	User guide	3
1.1.1	Abbreviations	3
1.1.2	Symbols	3
1.1.3	Target group	3
1.2	Service	4
1.3	Transportation and storage	4
1.3.1	Packaging regulations (applicable in Federal Republic of Germany only)	4
1.3.2	Damage in transit	4
1.3.3	Storage	5
2	Safety	7
2.1	Description of safety instructions	7
2.1.1	Warning symbol	7
2.1.2	Structure	7
2.1.3	Description of hazard levels	7
2.2	Purpose – Proper use	8
2.2.1	General information	8
2.2.2	Product-specific	9
2.3	Safety instructions	10
2.3.1	General information	10
2.3.2	Product-specific	10
3	Product description	11
3.1	QUATTROcare PLUS 2124 A	11
3.2	Rating plate	12
3.3	Technical data	12
3.4	Scope of delivery	14
4	First use	15
4.1	Select location	15
4.2	Connect the QUATTROcare PLUS 2124 A	16
4.3	Replacing the QUATTROcare Plus Spray canister	17
4.3.1	Insert the spray canister	18
4.3.2	Remove the spray canister	19
4.3.3	Dispose of the spray canister	20
5	Operation	21
5.1	Control panel	21
5.2	Open the front flap	21
5.3	Mounting instruments	22
5.4	Start the treatment	24
5.5	Remove the instruments	25
5.6	Reposition the treatment couplings	25
5.7	Chuck Servicing	26
5.8	Set the blow-out time	28
6	Maintenance	30
6.1	Cleaning	30
6.2	Safety checks ("STK")	31

Table of contents

7	Troubleshooting	32
8	Tools and consumables	34
9	Warranty terms and conditions	37
10	Glossary	38
	Index	40

1 User instructions





1.1 User guide

	 CAUTION
	<p>Incorrect operation. Damage to or malfunction of the unit.</p> <ul style="list-style-type: none"> ▶ Read these Instructions for Use before first start-up.

1.1.1 Abbreviations

Abbre- viation	Explanation
IfU	Instructions for use
CI	Care instructions
AI	Assembly instructions
TI	Technician's instructions
SC	Safety checks
IEC	International Electrotechnical Commission
RI	Repair instructions
RK	Retrofitting kit
AS	Assembly set
EP	Enclosed parts
EMC	Electromagnetic compatibility
PI	Processing instructions

1.1.2 Symbols

	See the Safety/Warning Symbols section
	Important information for users and technicians
	CE mark according to Medical Devices Directive EC 93/42
	Action required
	Wear safety goggles

1.1.3 Target group

This document is for dentists and dental office staff.

1.2 Service



KaVo Technical Service

If you have any technical questions or complaints, please contact the KaVo Technical Service:

+49 (0) 7351 56-1500
service.instrumente@kavo.com

KaVo Repair Service

For repairs, please contact your local dealer or the KaVo Repair Service directly:

+49 (0) 7351 56-1900
service.reparatur@kavo.com

KaVo Dental GmbH Customer Service Center

Bahnhofstraße 20
D-88445 Warthausen
+49 (0) 7351 56-1500
www.kavo.com

1.3 Transportation and storage

1.3.1 Packaging regulations (applicable in Federal Republic of Germany only)

Dispose of and recycle the sales packaging appropriately in accordance with current packaging regulations, employing waste management or recycling companies. Comply with the comprehensive return system. KaVo has had its sales packaging licensed for this purpose. Please comply with the regional public waste-disposal system.

1.3.2 Damage in transit



Note

KaVo shall not be held liable for damage arising from transportation. The shipment must be checked on arrival.

International

If the packaging is visibly damaged on delivery, please proceed as follows:

- ▶ Leave the product and packaging in the condition in which you received it.
- ▶ Do not use the product.

- ▶ Record the loss or damage on the delivery receipt. The recipient and the representative of the shipping company must sign this delivery receipt. Without this evidence, the recipient will not be able to assert a claim for damages against the shipping company.

If the product is damaged but there was no discernable damage to the packaging upon delivery, proceed as follows:

- ▶ Leave the product and packaging in the condition in which you received it.
- ▶ Do not use a damaged product.
- ▶ Report the damage to the shipping company without delay, definitely no later than 7 days after delivery.



Note

Failure on the part of the recipient to comply with any of the above-mentioned obligations will mean that the damage will be considered to have arisen following delivery (in accordance with CMR law, Chapter 5, Art. 30).

In Germany

If the packaging is visibly damaged on delivery, please proceed as follows:

- ▶ Leave the product and packaging in the condition in which you received it.
- ▶ Do not use the product.
- ▶ Record the loss or damage on the delivery receipt. The recipient and the representative of the shipping company must sign this delivery receipt.
- ▶ Report the damage to the shipping company.
- ▶ Report the damage to KaVo.
- ▶ Consult with KaVo first, before returning a damaged product.
- ▶ Send the signed delivery receipt to KaVo.

If the product is damaged but there was no discernable damage to the packaging upon delivery, proceed as follows:

- ▶ Leave the product and packaging in the condition in which you received it.
- ▶ Do not use a damaged product.
- ▶ Report the damage to the shipping company without delay, definitely no later than 7 days after delivery.
- ▶ Report the damage to KaVo.



Note

Failure on the part of the recipient to comply with any of the above-mentioned obligations will mean that the damage will be considered to have arisen following delivery (in accordance with the General German Freight Forwarders' Terms and Conditions, Art. 28).

1.3.3 Storage











Note

Please keep the packaging in case you need to return the product for servicing or repair.

1 User instructions | 1.3 Transportation and storage

The symbols printed on the outside are for transportation and storage, and have the following meaning:

	Temperature range -20 to 50°C (-4 to 122°F)
	Humidity 5% to 95% non-condensing
	Air pressure 700 to 1,060 hPa
	Transport upright
	Protect from impact
	Protect from moisture
	Permissible stacking load: 15 kg (33 pounds)
	Disposal



2 Safety

2.1 Description of safety instructions

2.1.1 Warning symbol



	Warning symbol
---	----------------



2.1.2 Structure



	 DANGER
	<p>The introduction describes the type and source of the hazard. This section describes potential consequences of non-compliance.</p> <ul style="list-style-type: none"> ▶ The optional step includes necessary measures for hazard prevention.

2.1.3 Description of hazard levels

Safety instructions distinguishing between three hazard levels are used in this document to prevent personal and property damage.



	 CAUTION
	<p>CAUTION indicates a hazardous situation that can cause damage to property or mild to moderate injuries.</p>



	 WARNING
	<p>WARNING indicates a hazardous situation that can lead to death or fatal injury.</p>

	 DANGER
	<p>DANGER indicates a maximal hazard due to a situation that can directly cause death or fatal injury.</p>

2.2 Purpose – Proper use

2.2.1 General information

	 CAUTION
	<p>Improper maintenance or repair of the unit. Damage to and malfunction of the unit.</p> <ul style="list-style-type: none"> ▶ Repair and servicing work on the electronic part of the unit may be done only by skilled staff or KaVo-trained technicians. ▶ Use original KaVo spare parts only.

	 CAUTION
	<p>Inappropriate installation location of the unit. Damage to and malfunction of the unit.</p> <ul style="list-style-type: none"> ▶ The unit is designed for indoor use only. ▶ Do not use the unit in areas where there is an explosion hazard.

The user must ensure that the unit works properly and is in satisfactory condition before each use.

According to these provisions, the user is responsible for:

- exclusive use of equipment that is operating correctly.
- compliance with the specified intended use.
- protecting himself and others against hazards.
- Compliance with the warnings on the device and in the Instructions for Use is mandatory.

The following persons are authorised to repair and service the KaVo product:

- Technicians of KaVo branch offices after appropriate product training.
- Specifically KaVo-trained technicians of KaVo franchised dealers.

The applicable national legal regulations must be observed during the use of the device, in particular the following:

- Applicable regulations governing the connection and start-up of medical devices.
- Current occupational safety regulations.
- Current accident prevention regulations.

KaVo shall not be responsible for damage caused by:

- external influences, poor media quality or faulty installation.
- The use of incorrect information.
- repair work carried out incorrectly.

Disposal of electronic and electrical devices



Note

According to EC directive 2002/96 concerning used electrical and electronic devices, this product is subject to the cited directive and must be disposed of accordingly within Europe.

For more information, please visit www.kavo.com or contact your specialised dental supplier.

For final disposal, please contact:

International

For country-specific information on disposal, please contact your dental supplier.

In Germany

To return an electrical device, you need to proceed as follows:

- ▶ On the homepage of enretec GmbH www.enretec.de, you can download a form for a disposal order under the menu item eom, or you can complete it as an online order.
- ▶ Please complete the disposal order entering the necessary data and submit it as an online order or by Fax +49 (0) 3304 3919-590.
- ▶ The following contact options are also available for questions and for initiating a disposal order:
Phone +49 (0) 3304 3919-500
enretec GmbH, Geschäftsbereich eomRECYCLING®, Kanalstraße 17, 16727 Velten, Germany
pickup@eomRECYCLING.com

A unit that is not permanently installed in the office will be picked up.

A permanently installed unit will be picked up at the curb at your address on the agreed date.

The owner or user of the device will have to bear the costs of disassembly, transportation and packaging.

2.2.2 Product-specific

The QUATTROcare PLUS 2124 A is designed for maintenance, servicing and removal of abrasion products from handpieces and contra-angle handpieces as well as turbines used for dental therapy.



Note

Compliance with the preceding and subsequent re-processing steps according to the recommendations of the Medical Devices Law and RKI guidelines is required although the QUATTROcare PLUS 2124 A services the straight and contra-angle handpieces and turbines to be re-processed and cleans the inner parts from mechanical abrasion.

2.3 Safety instructions

2.3.1 General information

	<p>⚠ WARNING</p>
	<p>Electrical power. Electrical shock. Damage to or malfunction of the unit.</p> <ul style="list-style-type: none"> ▶ Connect the device to a properly grounded and fuse-protected power source only. ▶ Check if the information on the rating plate of the unit (voltage, frequency) is consistent with the available electrical power supply. The rating plate is attached on the back panel of the device. ▶ Supply the device only with the voltage specified in the instructions for use, on the rating plate, and on the device. ▶ Only use extension cords that are permissible for the indicated rated voltage and are fitted with a protective conductor. ▶ Disconnect the unit from the power supply when you leave your practice.

2.3.2 Product-specific

	<p>⚠ WARNING</p>
	<p>Overheating. If the instrument with spray canister inserted heats up to above 50°C (122°F), there is a danger of explosion.</p> <ul style="list-style-type: none"> ▶ Protect the device from heating up to more than 50°C (122°F).

	<p>⚠ CAUTION</p>
	<p>Contaminated compressed air. Damage to and malfunction of the instrument.</p> <ul style="list-style-type: none"> ▶ In general, ensure dry, clean oil-free compressed air in accordance with EN ISO 7494-2.



Note

Compressed air

Malfunction of the device due to unsupervised supply of compressed air.

- ▶ When you leave your practice, disconnect the instrument from the compressed air connection.

3 Product description

3.1 QUATTROcare PLUS 2124 A

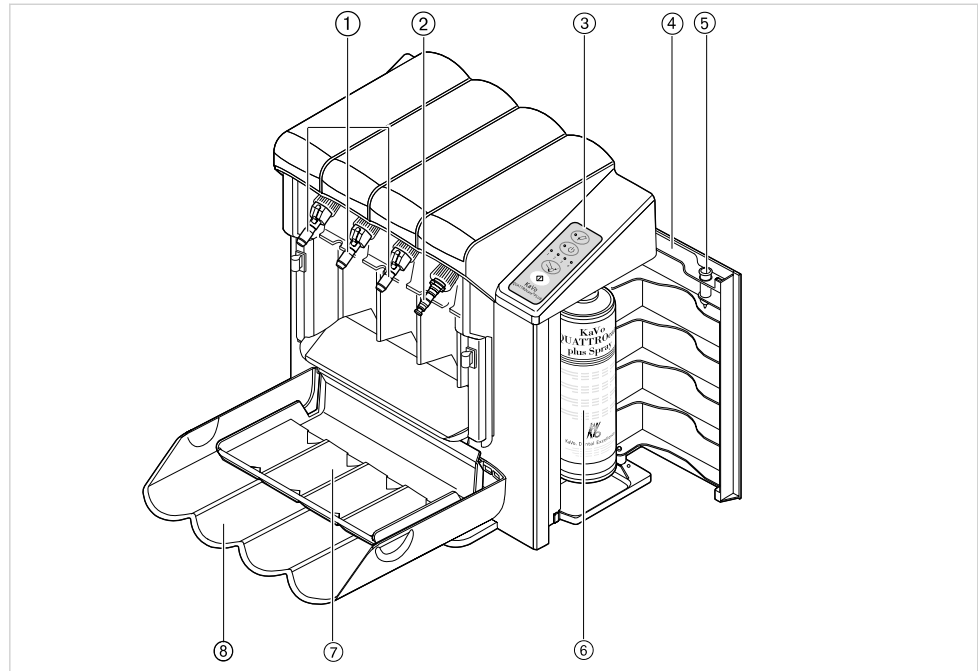

- ① 3x INTRAmatic service couplings
- ② 1x MULTIflex service coupling
- ③ Control panel and display
- ④ Door of spray can chamber
- ⑤ Service coupling chuck
- ⑥ QUATTROcare Plus Spray canister
- ⑦ Collecting pan
- ⑧ Front door

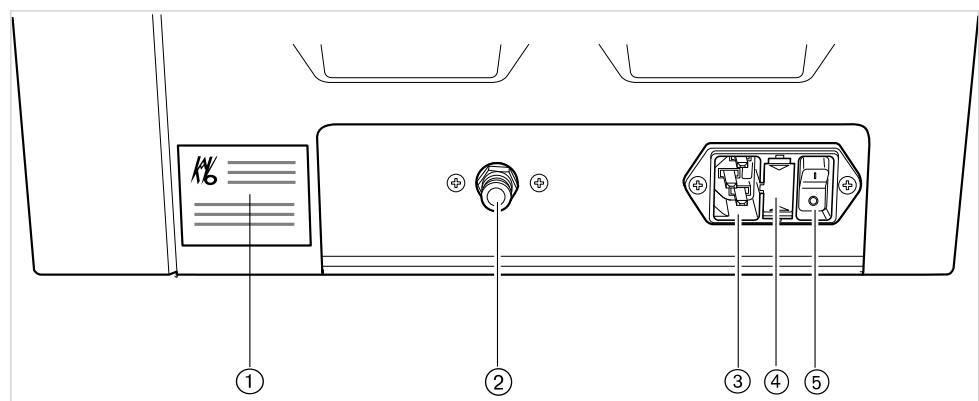





Back of QUATTROcare PLUS 2124 A

- ① Rating plate
- ② Compressed air connection
- ③ Input of mains voltage
- ④ Fuse
- ⑤ Main switch

3.2 Rating plate



Type	QUATTROcare PLUS 2124 A
SN	Year of manufacture - serial number
REF	Material number
	Fused with 1000 mA
	Observe instructions for use
	CE mark
	CSA mark
	Disposal information

3.3 Technical data

Device dimensions

Width	350 mm (1.15 feet)
Depth	280 mm (0.92 feet)
Height	380 mm (1.25 feet)
Weight	10 kg (22 pounds)

Electrical supply

Line voltage	100 to 240 VAC
Mains frequency	50 or 60 Hz
Power consumption	41 VA
Overvoltage category	II
Mains voltage fluctuation	±10 %

Compressed Air

Compressed air	0.4 to 0.6 MPa
Compressed air consumption	Approximately 50 NL/min
Air requirements	Dry, oil free, dirt free, uncontaminated in accordance with EN ISO 7494-2

Operating environment

Temperature	15 to 40°C (59 to 104°F)
Humidity	25 to 90 %
Degree of soiling	2
Permissible to a maximum	2000 m above sea level (6560 feet altitude)

Transportation and storage conditions

Temperature	-20 to 50°C (-4 to 122°F)
Humidity	5 to 95 % non-condensing
Air pressure	700 to 1060 hPa

3.4 Scope of delivery



Note

The package includes the articles listed below. If any of these articles is missing, please contact the supplier immediately so that the missing article can be delivered.

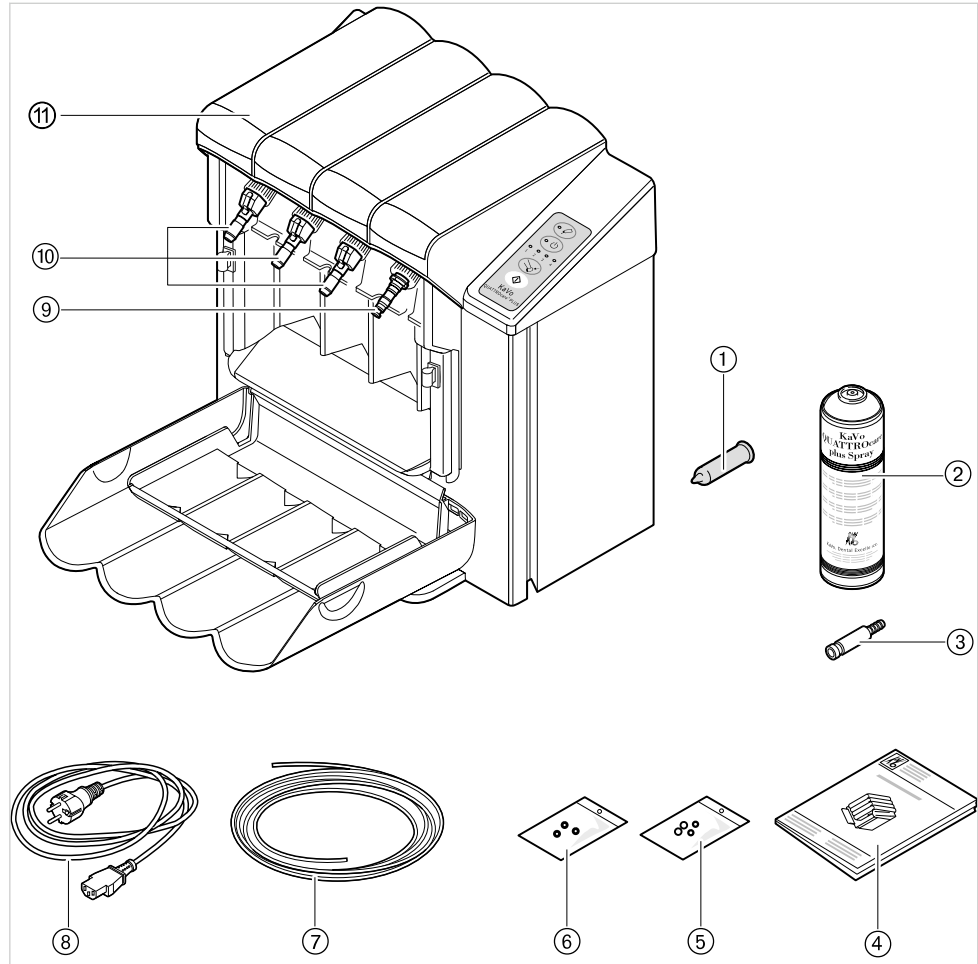





- | | |
|-----------------------------------|---|
| ① Clamping chuck service coupling | ⑦ Compressed air hose |
| ② QUATTROcare Plus Spray canister | ⑧ Power cable |
| ③ Compressed air coupling | ⑨ Service coupling MULTIflex |
| ④ Instructions for use | ⑩ Service coupling INTRAmatic (3 units) |
| ⑤ O-ring MULTIflex (4 units) | ⑪ QUATTROcare PLUS 2124 A |
| ⑥ O-ring INTRAmatic (3 units) | |

4 First use

4.1 Select location

The QUATTROcare Plus Spray canister contains explosive propellant gases. The following instructions and setup conditions therefore need to be observed when setting up the unit.

	 WARNING
	<p>Propellant gases of the QUATTROcare Plus spray canister. Explosive, flammable vapour/air mixtures may be produced during use. Risk of fire from overheating.</p> <ul style="list-style-type: none"> ▶ Do not expose the unit to direct sunlight. ▶ Do not place the unit right next to a source of heat. ▶ Keep away from ignition sources, and do not use open fire close by. ▶ Ensure sufficient ventilation of the premises.

	 CAUTION
	<p>Danger of overheating. Damage to and malfunction of the device.</p> <ul style="list-style-type: none"> ▶ Do not cover or obstruct the vents and openings on the unit. ▶ Maintain a minimum distance of 20 cm (8 inches) between the unit and the surfaces of walls or cabinets.



Note

Tests have demonstrated that the unit meets the requirements of EC Directive 2004/108/EC concerning electromagnetic compatibility. Even though the unit does not emit interfering radiation, other equipment (e.g., ultrasonic cleaners) can interfere with the unit. Keep the unit away from possible sources of interference.



Note

The unit must be set up on a flat, level surface that is insensitive to oil and water. The unit must not be set up or operated on an angled surface.

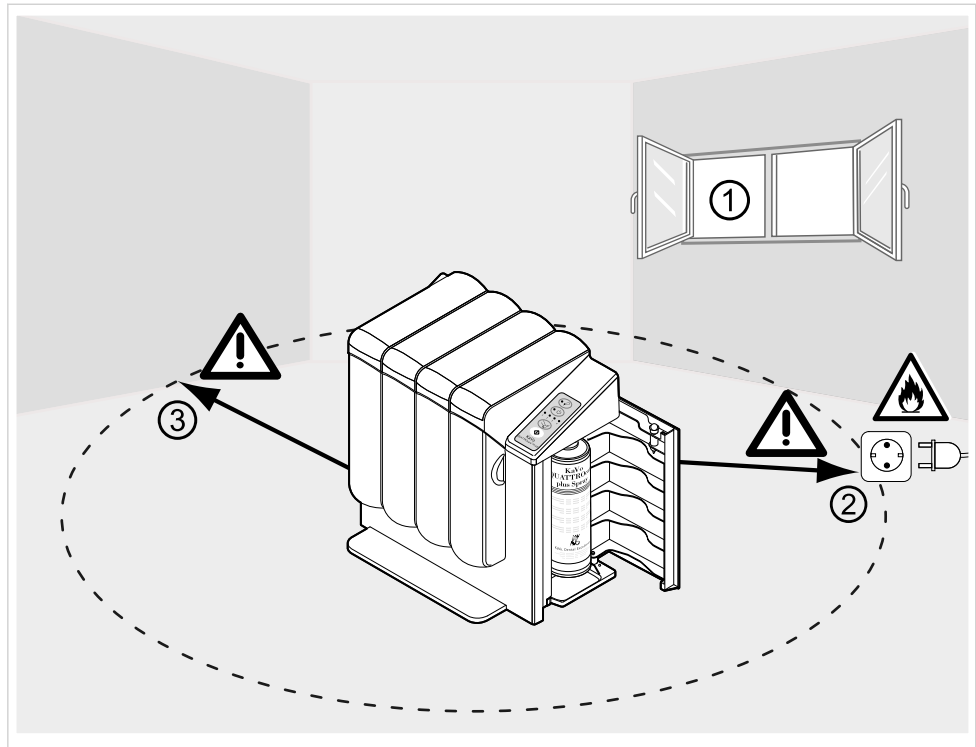

Installation requirement:

- It is mandatory to maintain a minimal distance of 20 cm (8 inches) ③ between the unit and wall or cabinet surfaces.
- Well-ventilated rooms ① are a suitable installation location. Do not expose to direct sunlight. Do not set up the unit in cabinets.
- Maintain a minimum distance of 50 cm (20 inches) ② from electrical plugs, light switches, and sources of ignition.
- Only operate the device in a clean environment such as that of a laboratory or dental practice.

4.2 Connect the QUATTROcare PLUS 2124 A

	<p>⚠ CAUTION</p>
	<p>Contaminated compressed air. Damage to and malfunction of the device.</p> <ul style="list-style-type: none"> ▶ The compressed air must be free of oil, dirt, and contamination. ▶ If needed: Use a compressor with a dry air system, if required, possible install an upstream air filter (on the compressor) or blow-out the lines before connecting them.



Note

Use of power cables other than original KaVo parts.
Damage to or malfunction of the unit.

- ▶ Use original KaVo power cables only (for material numbers, see chapter on "Consumables and tools").

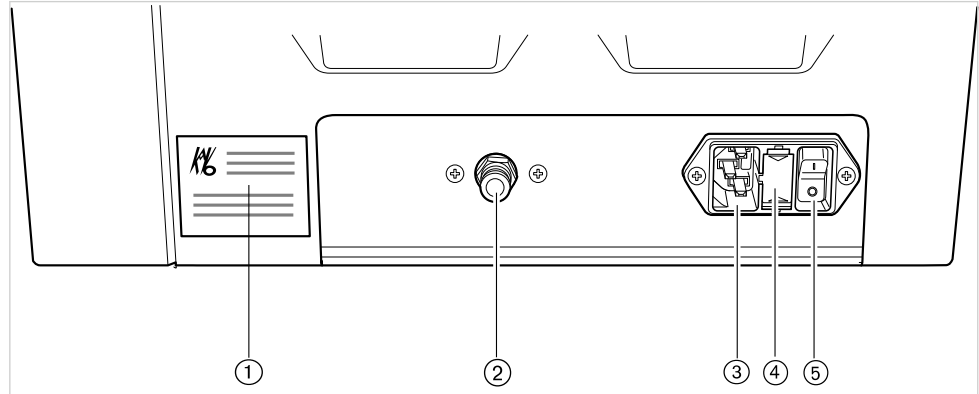

Back of QUATTROcare PLUS 2124 A

A T1000 mA fuse is installed ④.

- ▶ Plug the power cable into the electric socket ③.
- ▶ Plug the compressed air hose onto the compressed air connector ②.



Note

Compressed air hose must not be kinked.

- ▶ Turn the main switch ⑤ on.

4.3 Replacing the QUATTROcare Plus Spray canister



! WARNING

Use of servicing products other than original KaVo products.

The use of third-party products can shorten the product life, cause explosion, damage or malfunction.

- ▶ Always service KaVo products with original KaVo service products.



Note

KaVo advises explicitly that original KaVo service products must be used exclusively.

Only QUATTROcare Plus spray canisters bearing a bar code may be used. The QUATTROcare PLUS unit checks if the original spray can is being used. If a spray canister without a barcode or with a false bar code is inserted, the servicing device will indicate this as an error by means of a flashing LED.

See also: 7 Troubleshooting, Page 32

QUATTROcare plus Spray package with 6 canisters can be ordered using the following **Mat. no. 1.005.4525**.

4.3.1 Insert the spray canister



Wear safety goggles when you insert or replace the spray can. Please note the safety data sheet of the spray can.



Note

The safety data sheet of the QUATTROcare Plus Spray can be viewed at www.kavo.com.

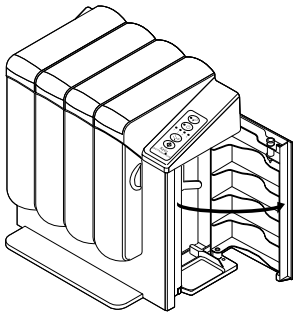

- ▶ Open the side door of the unit.

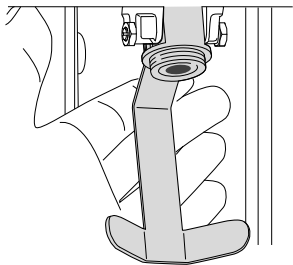

- ▶ Swing the adaptor on the retention clip outward.

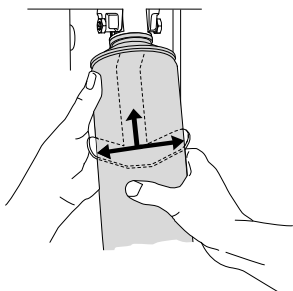

- ▶ Place the spray can on the retention clip and position it towards the thread.

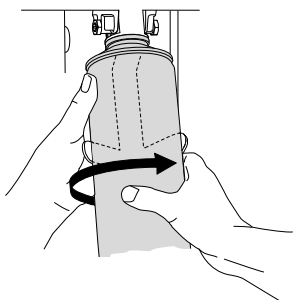

- ▶ Screw the spray can into the adaptor in clockwise direction and tighten until you notice a resistance. Do not jam it.

The sealing ring seals with respect to the canister connector.

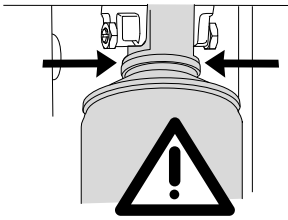

- ▶ Check the screw connection.



Note

After insertion of the spray can check visually, tactile, acoustically and by touch for absence of leakage. The spray can must rest flat against the adaptor. There must be no gap between the spray can and the adaptor. The connection must be tightly sealed.



Note

If any oil or gas leaks, you need to use a different spray can.



- ▶ Swing the canister and adaptor back into the instrument.

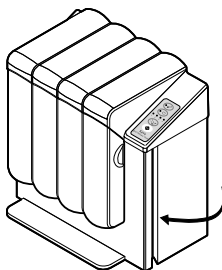

- ▶ Close the side door of the instrument.

4.3.2 Remove the spray canister

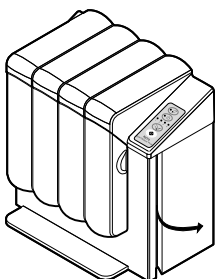

- ▶ Open the side door of the unit.

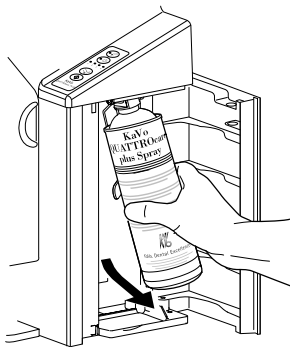

- ▶ Swing the spray can and the adaptor out of the device.

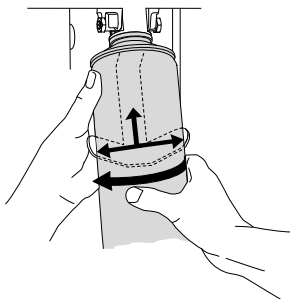

- ▶ Place the spray can on the retention clip and unscrew it counterclockwise from the adaptor.

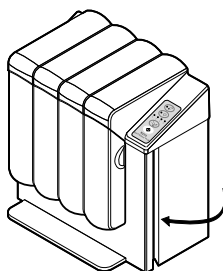

- ▶ Close the side door of the unit.

4.3.3 Dispose of the spray canister

- ▶ Dispose of the spray can in empty condition.



Note

Waste code according to the European waste catalogue: 15 01 04 - metals, packaging, empty.

See also: Safety data sheet QUATTROcare Plus Spray.

5 Operation

5.1 Control panel

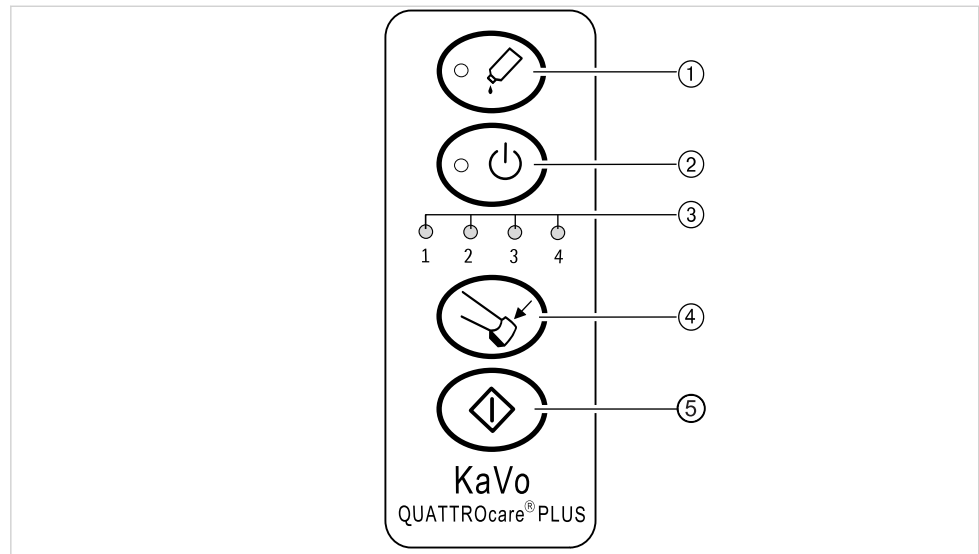

- ① LED spray bottle control
- ② LED main switch (on/off)
- ③ LED display

- ④ Start button for chuck maintenance
- ⑤ Start button for servicing procedure

5.2 Open the front flap



Note

Objects on or in the front door.

Placing objects on or in the front door can damage the unit.

- ▶ Do not place any objects on or in the front door.

- ▶ Grasp the recesses on the left and right of the front door. Pull forward and fold down to open it.

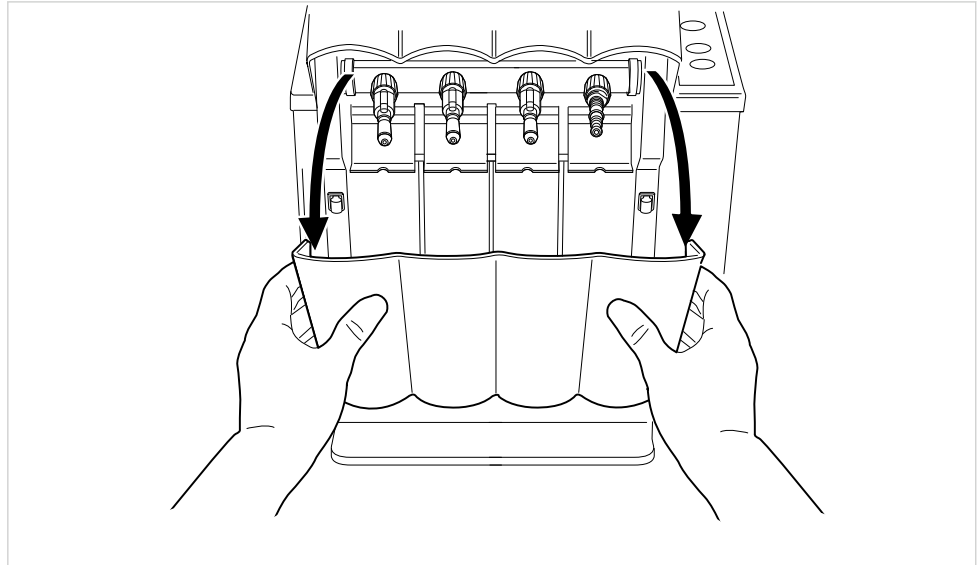

5.3 Mounting instruments



Note

Remove the handpieces from the unit as soon as the servicing is completed.



Note

The LED display shows the following:

Adaptor on the far left corresponds to LED display 1.

Adaptor on the far right corresponds to LED display 4.



Note

Not every adaptor has to be used.



Note

Heads of the "22" series cannot be serviced because their necks are too thin. These heads must be serviced together with the corresponding shanks.

- ▶ Mount turbines on the MULTIflex service coupling (service coupling on the far right) and lock them into place.

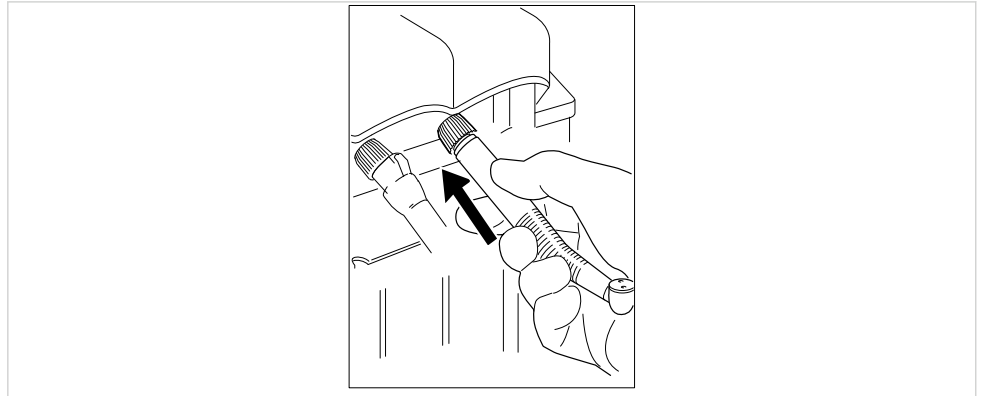

- ▶ Mount straight and contra-angle handpieces on the INTRAMatic service coupling (service coupling on the far left or second or third from the left) and lock them into place. Working with LUX handpieces, make sure the latch is in the correct position.

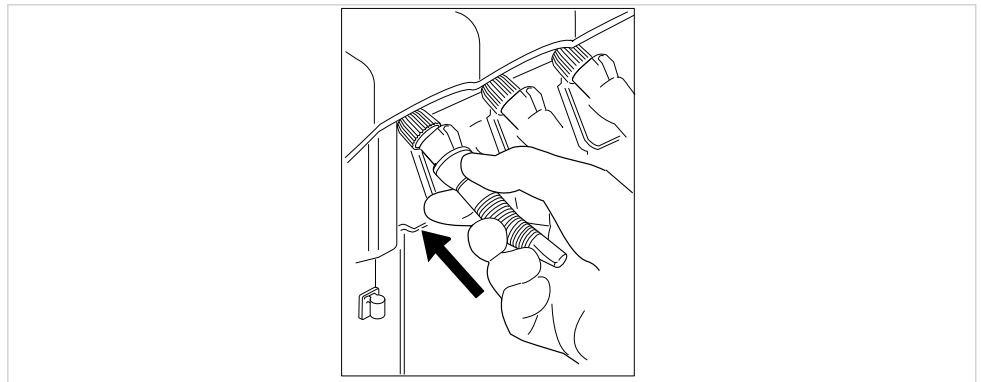

- ▶ Mount heads on the service coupling for INTRA heads (for Special accessories, see chapter on "Consumables and tools"). Push back the locking sleeve ① and snap it in place.
- ▶ When installing the service coupling for INTRA heads, make sure to push the actuating sleeve ② (for Special accessories, see chapter on "Consumables and tools") onto the associated flap to ensure proper servicing.

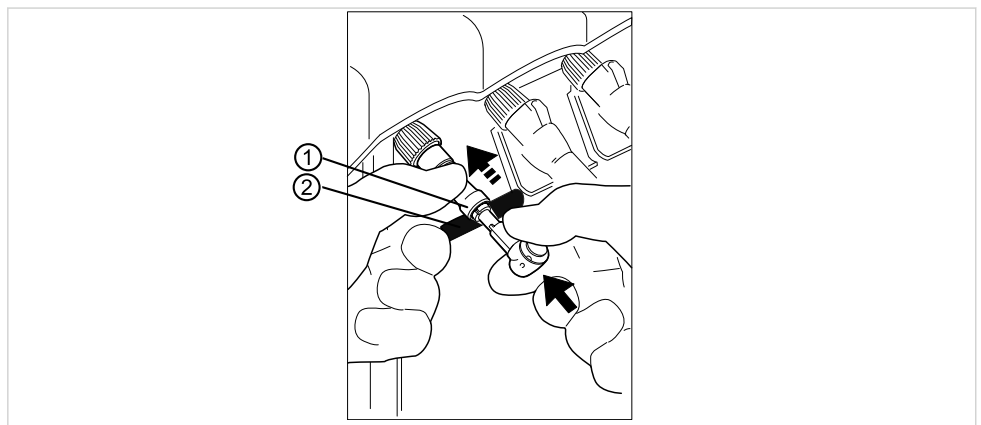

- ▶ Push the front door up and close it.

5.4 Start the treatment

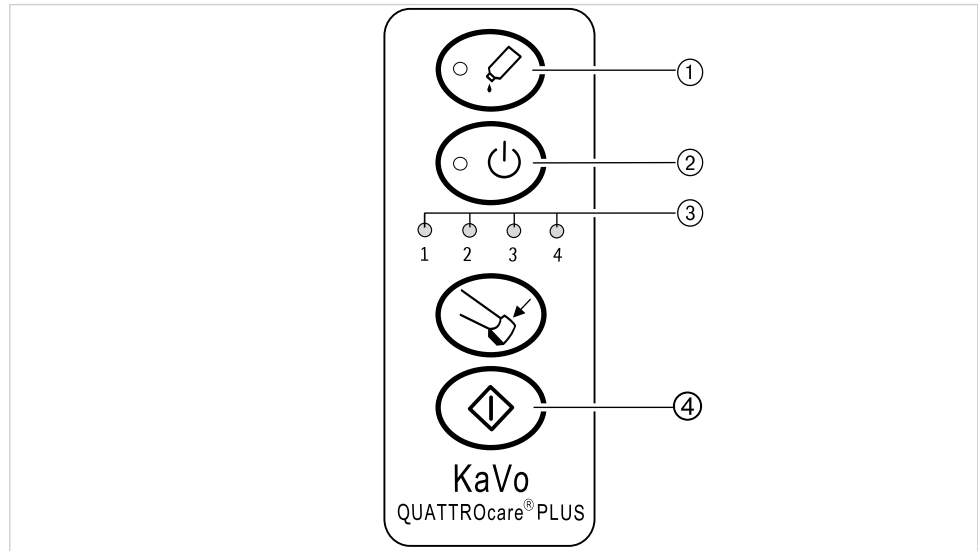

Note

The LED of the spray canister control ① lighting up indicates that the spray can is empty or inserted incorrectly.

When the main switch is on, the LEDs ③ light up.

- ▶ Press the start key ④.

The automatic servicing process starts.



Note

The automatic servicing time per handpiece is 15-40 seconds depending on the set blow-out time.

After the servicing process is completed, the LEDs ③ of the couplings in use light up and an acoustic signal is emitted.

The LEDs ③ continue to be lit until the front door is opened. The service procedure is now completed.

- ▶ Open the front door.

See also: 5.2 Open the front flap, Page 21

The LED display ③ is turned off.

5.5 Remove the instruments



Note

The exterior of handpieces needs to be wiped off thoroughly before removing them.

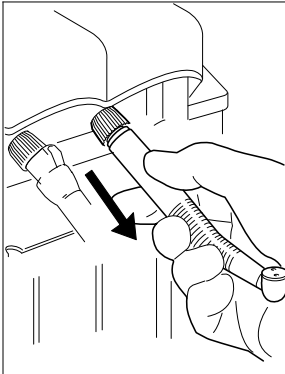

- ▶ Pull the turbine in the axial direction of the service coupling, and take it off.

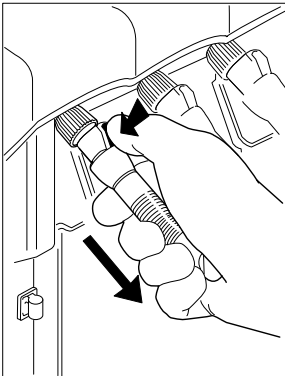

- ▶ Press on the latch with a thumb and take the straight or contra-angle handpiece off by simultaneously pulling in the direction of the axis of the service coupling.

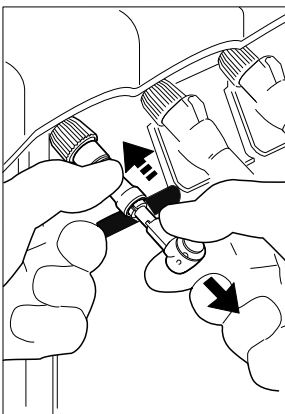

- ▶ Push back the locking sleeve and take off the head.

5.6 Reposition the treatment couplings



Note

The MULTIflex coupling must always be positioned on servicing station 4 (far right).



Note

Couplings with a 4-hole standard connector for third-party products can also be mounted. See chapter on "Consumables and tools".

The unit is configured as follows at the time of delivery:

- 3 x service couplings for INTRAmatic
- 1 x service coupling for MULTIflex

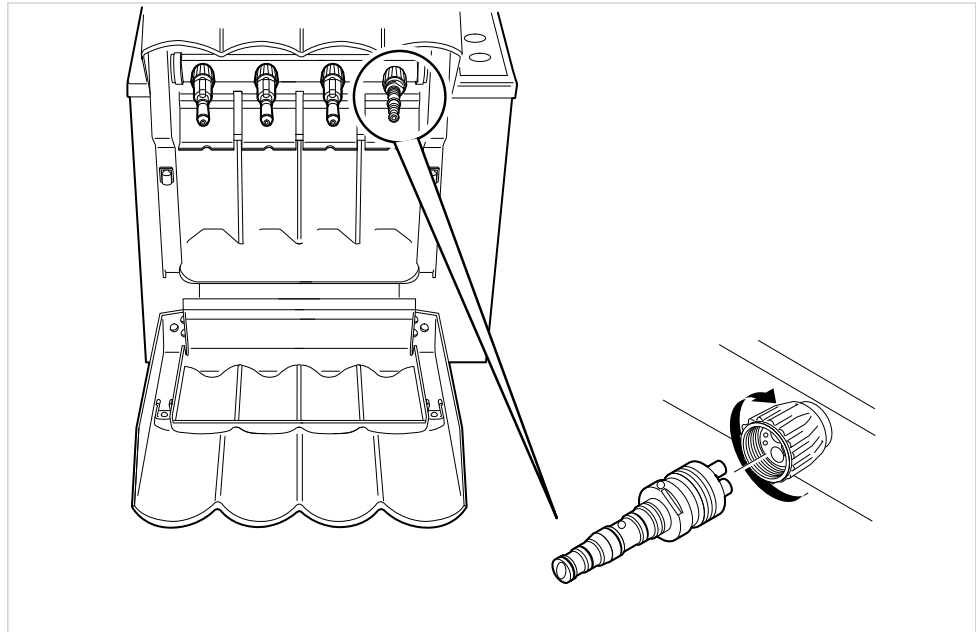

- ▶ Unscrew the union nut clockwise in the direction of the arrow, and take the service coupling off.
- ▶ Attach the KaVo service couplings as selected and fasten them turning the union nut counterclockwise against the direction of the arrow.

5.7 Chuck Servicing

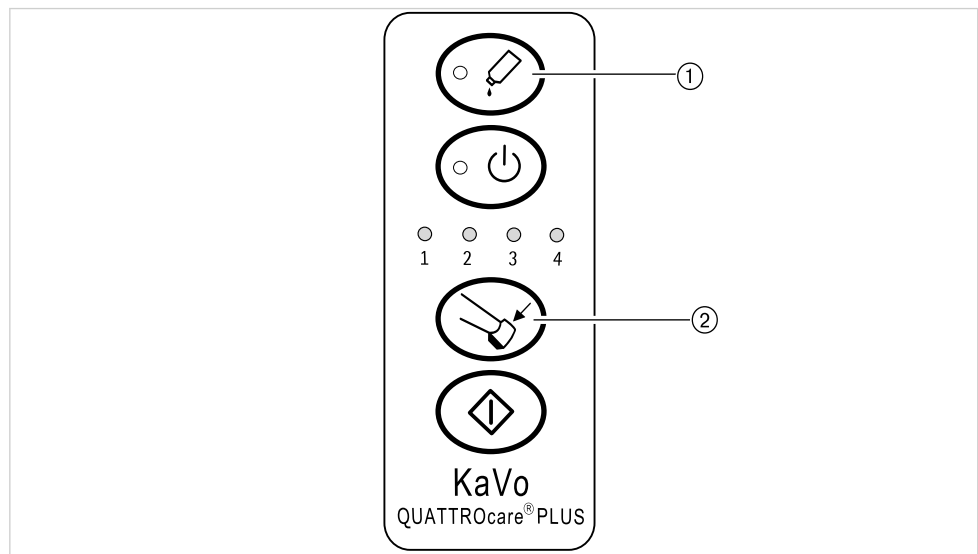



Note

Handpieces must be taken off the service couplings before the chuck service can be started and performed.



Note

Please cover the head region of the handpiece with a paper tissue to prevent any contamination of the ambient area during chuck service.

- ▶ Close the front door and press the chuck service button ② for at least three seconds until the spray canister control LED ① flashes three times consecutively.

The device is in chuck service mode.

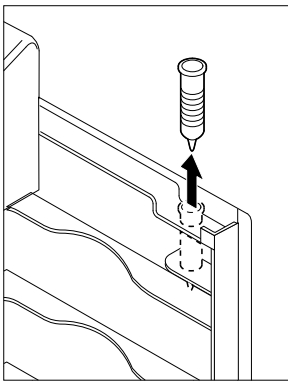

A holder for accommodating the chuck service coupling is provided in the side door. The service coupling is included in the accessories package at the time of delivery.

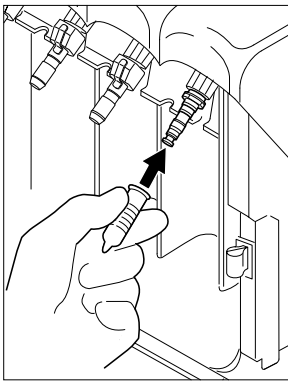

- ▶ Take the chuck service coupling out and attach it to coupling service point 4 (on the far right). A MULTIflex adaptor must be mounted on the coupling.

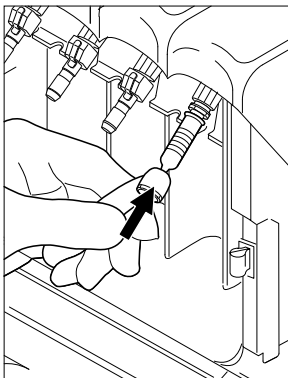

- ▶ Press the handpiece, with the chuck to be serviced leading, against the tip of the chuck service coupling.



Note

If this is done with insufficient pressure, there is a risk of the chuck service coupling being pushed off the service coupling during the servicing and of the servicing agent leaking.

- ▶ Press the chuck service button ②.

The spray is then briefly injected through the chuck, completing the service.

Quit the chuck service mode:

- Place the handpieces in the QUATTROcare PLUS 2124 A, close the front door and start the service procedure.
- Alternatively, after three minutes with no service procedure running, the device automatically switches back to normal service mode.

5.8 Set the blow-out time

With the QUATTROcare PLUS 2124 A the blow-out time for straight and contra-angle handpieces and turbines can be changed.

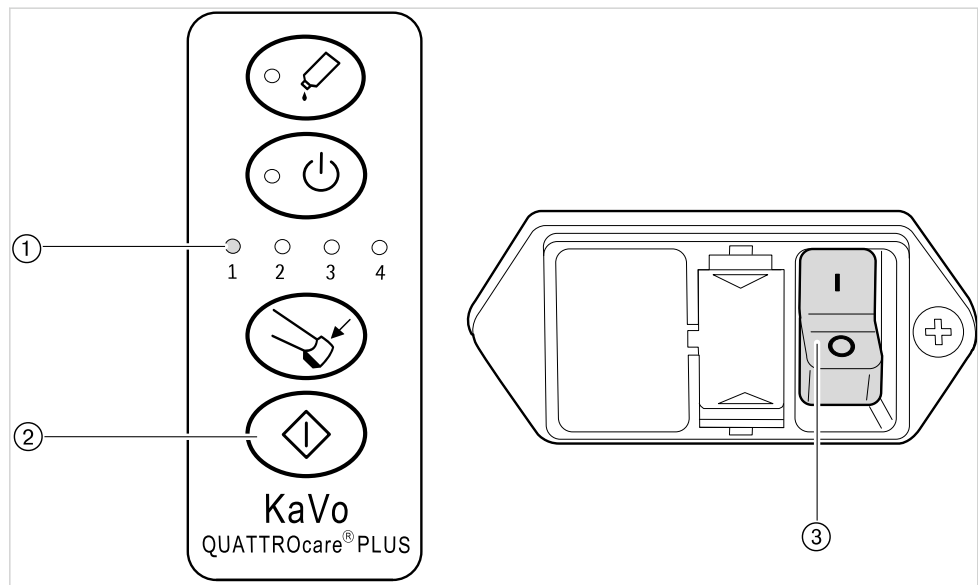

- ▶ Turn the main switch ③ on.
- ▶ Hold down the start key ②.

LEDs 1 to 4 of the LED display ① light up one after the other.

The blow-out time is as follows for:

- LED 1: 15 seconds
- LED 2: 20 seconds
- LED 3: 30 seconds
- LED 4: 40 seconds

- ▶ Release the start key ② for the desired blow-out time.

An acoustical signal is emitted if a blow-out time was set on the unit.

6 Maintenance

6.1 Cleaning

	⚠ CAUTION
	<p>Hazard from liquid inside the device. Liquid inside the unit can cause malfunction of the unit.</p> <ul style="list-style-type: none"> ▶ When cleaning, make sure that no liquid enters the device.



Note

Do not use solvents or aggressive chemicals for cleaning as these may cause damage to the unit.

- ▶ Wipe down all external and internal surfaces of the unit using a soft cloth and mild liquid cleanser.

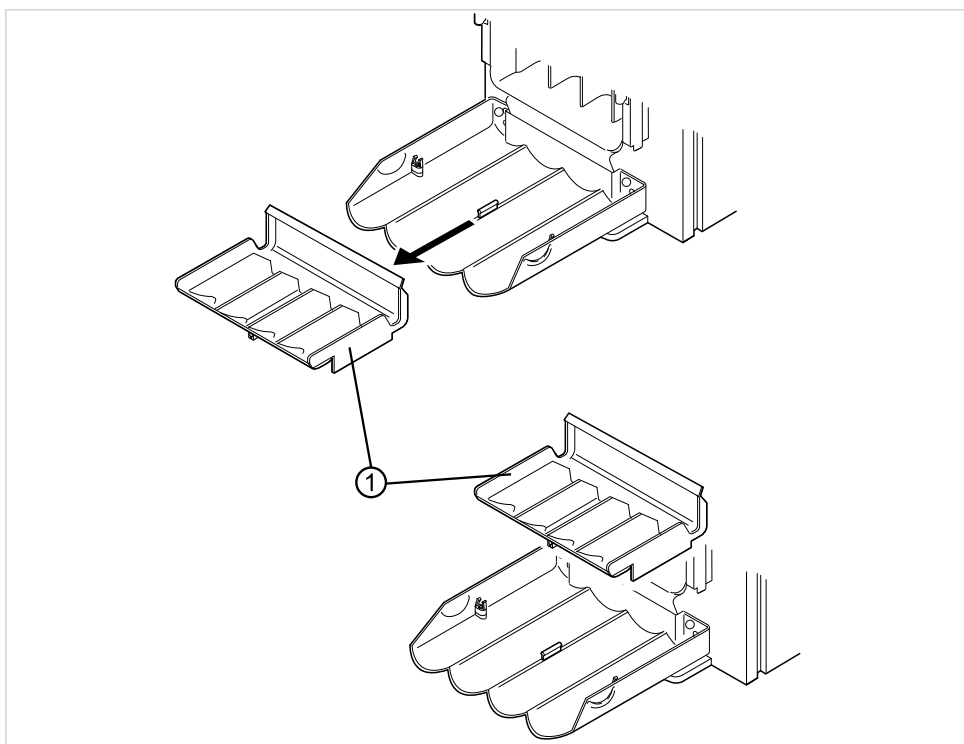

- ▶ Remove and clean the collecting pan ①.

The collecting pan ① can be washed in the dishwasher and in the thermodisinfectator:

- Temperature: max. 95°C (203°F)
- Time: max. 60 minutes

- ▶ Insert the collecting pan ① after cleaning. Make sure that the collecting pan properly locks into place.

6.2 Safety checks ("STK")

The QUATTROcare PLUS 2124 A must be subjected to a service check including safety check ("STK") every 5 years. The safety check may only be done by a professional trained by KaVo or in a shop trained by KaVo. Perform the safety check as described in the KaVo technician's instructions.

7 Troubleshooting

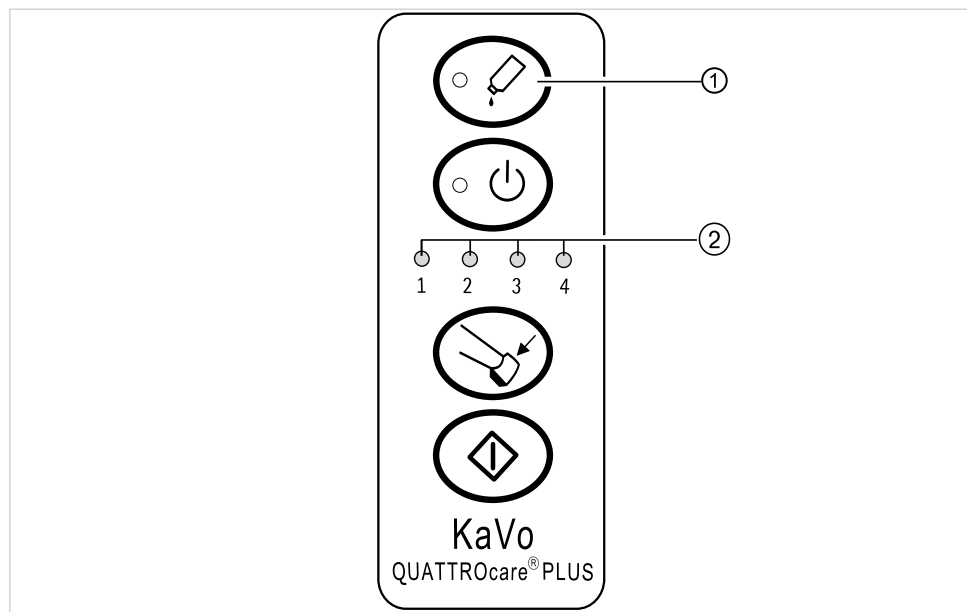

Note







Heads of the "22" series cannot be serviced because their necks are too thin. These heads must be serviced together with the corresponding shanks.

Malfunction	Cause	Remedy
The red LED ① flashes. Signal is emitted.	Spray can is not properly inserted. Spray can is empty.	Insert spray can properly. Insert different spray can. See also: 4.3.2 Remove the spray canister, Page 19 See also: 4.3.1 Insert the spray canister, Page 18
The red LED ① flashes during the service cycle.	The bridging function is activated.	Insert original KaVo spray canister. Notify the KaVo Service Team.
Flashing LED light ② is on.	Bar code is not detected or cannot be read.	Insert original KaVo spray canister. Notify the KaVo Service Team.
Green LEDs ② flash. Signal is emitted.	Front door was opened prematurely. The handpiece fell off the adaptor during the service.	Wait for the service procedure to be completed and an audio signal to be emitted. Properly mount the handpiece. Repeat the service procedure.

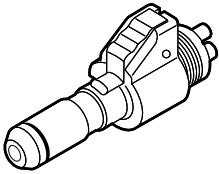
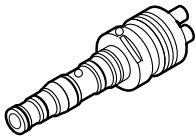
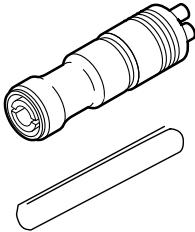
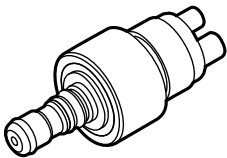
7 Troubleshooting

Malfunction	Cause	Remedy
Oil leaks from the handpiece after servicing.	The set blow-out time is too short.	Set a longer blow-out time. See also: 5.8 Set the blow-out time, Page 28
LED ② 1 and 3 flash alternately with 2 and 4. A signal is emitted.	Fan is blocked or defective.	Replace the fan. Notify the KaVo Service Team.

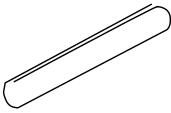
8 Tools and consumables

Presentation	Material summary	Mat. No.
	Service coupling INTRAmatic	0.411.7981
	Service coupling MULTIflex	0.411.7991
	Service coupling for IN- TRA heads includes actuating sleeve	0.411.7941
	Service coupling COMFORTdrive	1.005.1707
	O-ring INTRAmatic	0.200.6089
	O-ring MULTIflex	0.200.6098
	O-ring MULTIflex	0.200.6177
	Seal for service coupling for INTRAmatic, MULTIflex or heads	0.553.1872
	Actuating sleeve	0.411.5532
	Service coupling chuck	0.411.7603

8 Tools and consumables

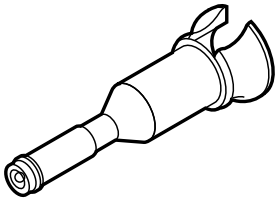
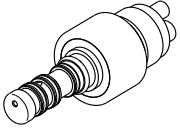
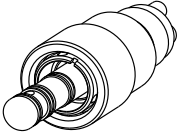
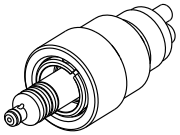
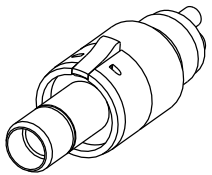
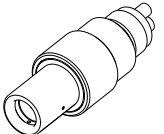
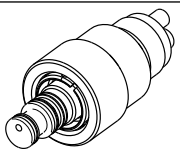
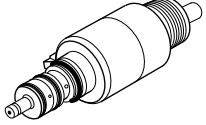
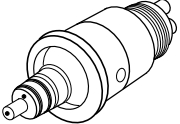
Presentation	Material summary	Mat. No.
	Service adaptor SIRONA Straight and contra-angle handpieces	1.000.1003
	Service coupling SIRONA T1 Turbines	1.000.7156
	Service coupling YOSHIDA Turbines with light	1.000.7403
	Service coupling YOSHIDA Turbines without light	1.000.7585
	Service coupling MIDWEST Low Speed	1.000.8459
	Service coupling NSK Turbines	1.000.8786
	Service coupling OSADA Turbines	1.000.8858
	Service coupling BIEN-AIR	1.001.7860
	Service coupling W&H	1.001.7888

8 Tools and consumables

Presentation	Material summary	Mat. No.
	QUATTROcare Plus Spray canister 2140 P (pack of 6 cans)	1.005.4525

Presentation	Material summary	Mat. no.
	Power cable	0.223.4142
	Power cable Switzerland	0.692.6881
	Power cable USA/Canada/Japan	0.692.6891
	Power cable United Kingdom	0.692.6901
	Power cable Australia	0.692.6851
	Power cable China	1.004.3850

9 Warranty terms and conditions

KaVo grants the end customer a warranty concerning the proper function of the product and absence of defects related to the material or workmanship for a period of 12 months from the purchasing date, subject to the following conditions: Upon justified complaints of flaws or a short delivery, KaVo will make good its warranty by replacing the product free of cost or repairing it according to the customer's wishes. Other claims of any nature whatsoever, in particular with respect to compensation, are excluded. In the event of default and gross negligence or intent, this shall only apply in the absence of mandatory legal regulations to the contrary.

KaVo cannot be held liable for defects and their consequences due to natural wear, improper cleaning or maintenance, non-compliance with operating, maintenance or connection instructions, calcination or corrosion, contaminated air or water supplies or chemical or electrical factors deemed abnormal or impermissible in accordance with factory specifications.

As a matter of principle, the warranty does not extend to lamps, glassware, rubber parts and the colourfastness of plastics.

Defects or their consequences that can be attributed to interventions on or changes made to the product by the customer or a third party are excluded from the warranty.

10 Glossary

4-hole standard connection	Special standardised connection for handpieces. Allows four different components, e.g. air and water, to be supplied to the handpiece.
Adaptor	Adaptor is the name of a part of the QUATTROcare PLUS 2124 A to which another component can be attached or screwed.
Blow-out time	Period of time for which the handpieces are blown-out with compressed air in the QUATTROcare PLUS 2124 A in order to remove the servicing oil that was earlier pumped into the interior of the handpieces. Depending on the set blow-out time, more or less servicing oil remains inside the handpiece.
Third-party product	Product made by another manufacturer of dental products.
Front door	Large door on the front that needs to be opened to place handpieces in the QUATTROcare PLUS 2124 A.
Retention clip	Metal guide facilitating the insertion of the QUATTROcare PLUS spray canister.
Straight and contra-angle handpiece	Electric power-driven rotating dental handpiece.
Main switch	Switch allowing the unit to be disconnected from the electrical power supply.
Handpieces	Includes the product groups of turbines, straight and contra-angle handpieces, and heads.
KaVo	Kaltenbach & Voigt GmbH with headquarters in Biberach a. d. Riß, Germany.
Head	Part of an electric power-driven rotating dental handpiece. Heads are attached to special shanks for treatment of patients.
Flashing LED light	The 4 LEDs of the LED display light up one after the other in rapid succession.
Service procedure	Procedure for the fully automated servicing of handpieces in the QUATTROcare PLUS 2124 A. The procedure includes servicing oil being pumped through the handpiece from the QUATTROcare PLUS spray canister and the handpieces subsequently being blown-out. A service procedure in the QUATTROcare PLUS 2124 A takes between 15 and 40 seconds to be completed.

Service coupling	Adaptors and/or couplings to which the handpieces are attached for servicing. The QUATTROcare PLUS 2124 A has the following service couplings: <ul style="list-style-type: none"> - Service coupling INTRAmatic for KaVo-made straight and contra-angle handpieces - Service coupling MULTIflex for KaVo turbines - Service coupling INTRA heads for KaVo heads - Service couplings for third-party products not made by KaVo
Servicing products	Agents that prolong the service life of a product or are required for operation of a product. For example the servicing oil of the QUATTROcare PLUS spray canister is a servicing product of the QUATTROcare PLUS 2124 A.
QUATTROcare PLUS Spray	Special servicing oil developed by KaVo for servicing handpieces in the QUATTROcare PLUS 2124 A. The servicing oil is a consumable required for operation of the QUATTROcare PLUS 2124 A.
Snap-in sleeve	A snap lock or snap-in sleeve on the service coupling needs to be released to remove the straight and contra-angle handpieces or heads.
Actuating sleeve	Tool needed for servicing heads in the QUATTROcare PLUS 2124 A.
Chuck service	Specialised service procedure, in which parts that are subject to wear and tear are removed from the chuck system (drill holding system) of the handpiece.
Spray can chamber	The spray can chamber is an internal region on the side of the QUATTROcare PLUS 2124 A that is closed through a door. The spray can chamber accommodates the QUATTROcare PLUS spray can.
Turbine	Air-driven rotating dental handpiece.
Rating plate	Contains important information about the unit, e.g. year of manufacture and serial number. The rating plate of the KaVo QUATTROcare PLUS 2124 A is attached on the back of the unit. Have the information on the rating plate on hand for all inquiries with Service.
Abrasion products	Abrasion products are produced by mechanical abrasion on the inside of handpieces during their operation and use. Abrasion products usually include tiny metal chips and residues of lubricants.

Index

4-hole standard connector 26

actuating sleeve 23, 34

Actuating sleeve 34

adaptor 18, 19, 20, 22, 27, 32

Adaptor 22

bar code 17

Bar code 32

blow-out time 24, 28, 29, 33

blow-out time 28

canister 19

chuck maintenance 21

chuck service 27, 28

chuck service button 27

chuck service coupling 27, 28

Clamping chuck service coupling 14

Close the front door 27

Close the side door 19

collecting pan 30

Collecting pan 11

compressed air 10, 16

Compressed air 13

compressed air connection 10

Compressed air connection 11

compressed air connector 17

Compressed air consumption 13

Compressed air coupling 14

compressed air hose 17

Compressed air hose 14, 17

disposal 9

Disposal 6

disposed of 9

Electrical power 10

fan 33

Fan 33

front door 21, 22, 24, 28

Front door 11, 32

handpieces 25

Handpieces 27

heads 23, 34

Heads 22, 32

INTRAmatic 11, 14, 23, 26, 34

KaVo 4, 5, 8, 17, 26, 31, 32, 33

latch 23, 25

LED display 21, 22, 24, 28

liquid cleanser 30

locking sleeve 23, 25

main switch 17, 21, 24, 28

Main switch 11

MULTIflex 11, 14, 23, 25, 26, 27, 34

power cable 17

Power cable 14, 36

propellant gases 15

Propellant gases 15

QUATTROcare Plus Spray 20

Index

QUATTROcare Plus spray canister	15
QUATTROcare Plus Spray canister	11, 14, 36
rating plate	10
Rating plate	11
retention clip	18, 20
safety goggles	18
Service coupling chuck	11, 34
service procedure	28, 32
service products	17
servicing	28
servicing agent	28
servicing procedure	21
servicing process	24
side door	18, 19, 20, 27
spray bottle control	21
spray can	18, 19, 20, 24, 32
Spray can	32
spray can chamber	11
spray canister	10, 32
spray canister control	24
spray canister control LED	27
straight and contra-angle handpieces	9, 23, 28
Straight and contra-angle handpieces	35
The compressed air	16
thermodisinfectior	30
third-party products	26
turbines	9, 23, 28
Turbines	35
union nut	26
Wear safety goggles	3

